

Pianoalto ¹²⁷²

Pianoalto 96 ¹²⁷³



Design

Ludovica+Roberto Palomba

2012

Divani monoblocco, componibili, pouf

Piedini in acciaio verniciati colore grafite. Struttura in legno. Molleggio su nastri elastici. Imbottitura sedile in poliuretano/Dacron Du Pont con inserto trapuntato in piuma d'oca. Imbottitura schienale e braccioli in poliuretano/Dacron Du Pont con inserto trapuntato in piuma d'oca e fiocchi di fibra poliestere. Imbottitura cuscini schienale in poliuretano/Dacron Du Pont o in piuma d'oca. Rivestimento sfilabile in stoffa o in pelle.

Monobloc and modular sofas, pouf

Graphite painted steel feet. Wooden frame. Elastic strips suspension. Seat upholstered in polyurethane/Dacron Du Pont with quilted insert of goose feathers. Backrest and armrests upholstered in polyurethane/Dacron Du Pont with quilted insert of goose feathers and polyester fibre flakes. Back cushions upholstered in polyurethane/Dacron Du Pont or in goose feathers. Removable cover in fabric or leather.

Canapés monoblocs, composables, pouf

Pieds en acier verni graphite. Structure en bois. Suspension sur sangles élastiques. Rembourrage de l'assise en polyuréthane / Dacron Du Pont avec insertion matelassé en plume d'oie. Rembourrage du dossier et des accoudoirs en polyuréthane/Dacron Du Pont avec insertion matelassé en plume d'oie et flocons de fibre polyester. Rembourrage des coussins du dossier en polyuréthane/Dacron Du Pont ou en plume d'oie. Revêtement déhoussable en tissu ou en cuir.

Einteilige, zusammenstellbare Sofas, Hocker

Füße aus graphitfarben lackiertem Stahl. Gestell aus Holz. Federung auf elastischen Gurten. Sitzpolsterung aus Polyurethan/Dacron Du Pont mit Steppeinsatz aus Gänsefedern. Polsterung von Arm- Rückenlehne aus Polyurethan/Dacron Du Pont mit Steppeinsatz aus Gänsefedern und Flocken aus Polyesterfasern. Polsterung der Rückenissen aus Polyurethan/Dacron Du Pont oder aus Gänsefedern. Abnehmbarer Bezug aus Stoff oder Leder.

Sofás monobloques, modulares, pouf

Pies de acero lacados en grafite. Estructura de madera. Suspensión con cintas elásticas. Asiento acolchado de poliuretano/Dacron Du Pont con inserción de pluma de ganso. Respaldo y brazos acolchados de poliuretano/Dacron Du Pont con inserción de pluma de ganso y copos de fibra de poliéster. Cojines de respaldo acolchados de poliuretano/Dacron Du Pont o pluma de ganso. Tapizado desenfundable de tejido o piel.

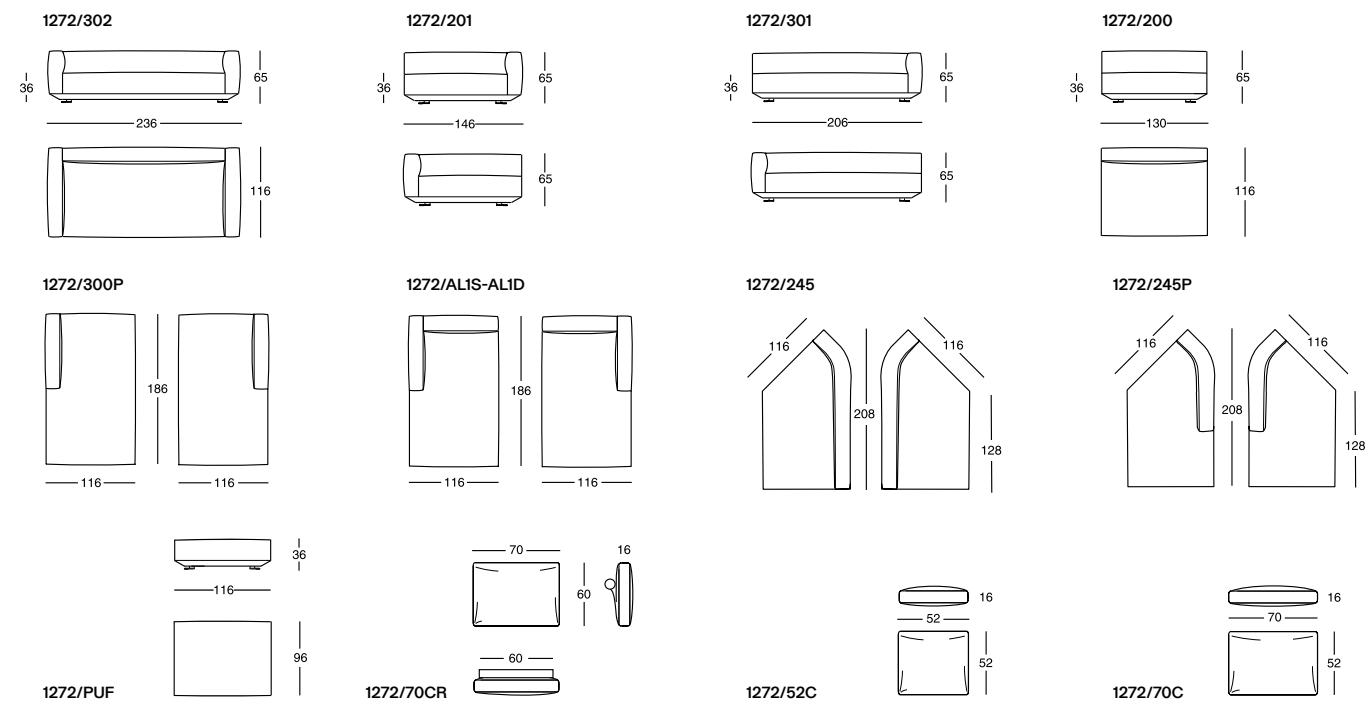



1273/212

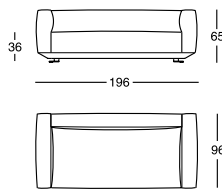

1273/302

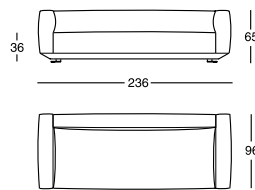

1273/201

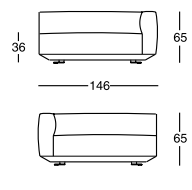

1273/301

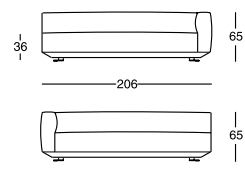

1273/300P

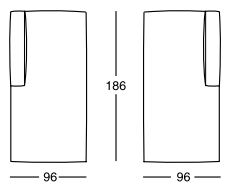

1273/ALIS-ALID

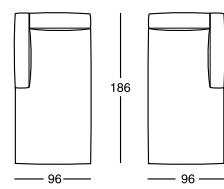

1273/200

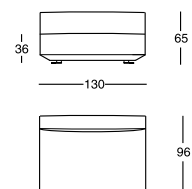

1272/PUF

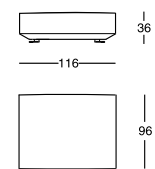

1273/52C

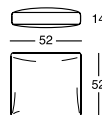

1273/70C

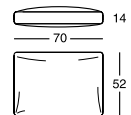

1.

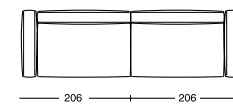

2.

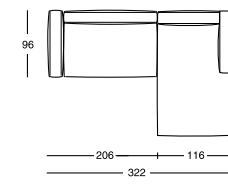

3.

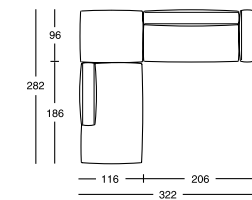

4.

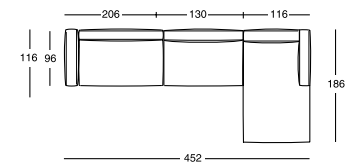

5.

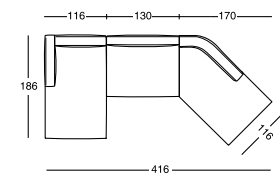

6.

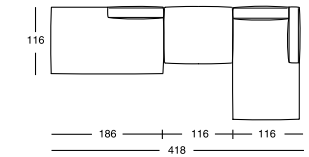

7.

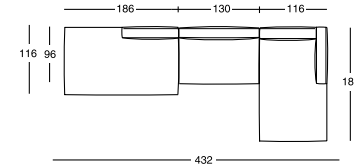

8.

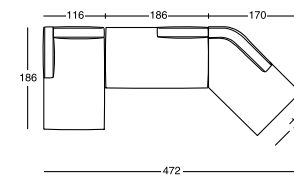

9.

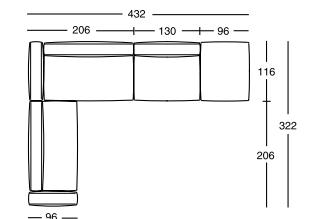

10.

